

# Instruction Manual

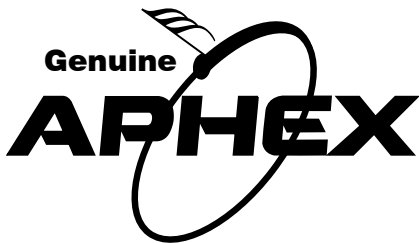

Models 1401 - 1402 - 1403





# Instruction Manual

Aphex P/N xxx-xxxx

Models Covered:	1401 Acoustic Xciter™
	1402 Bass Xciter™
	1403 Guitar Xciter™

All models have similar controls and features. The range of adjustments and the internal parameters are individually optimized for the different classes of musical instruments.

## Contents

1. Hook-up .....	4
2. Controls .....	8
3. Tune-Up.....	11
4. Theory.....	14
5. Specifications.....	21
6. Limited Warranty.....	22
7. Service Information.....	23

Copyright 2002 Aphex Systems Ltd.  
All Rights Reserved.

# 1. Hook-Up

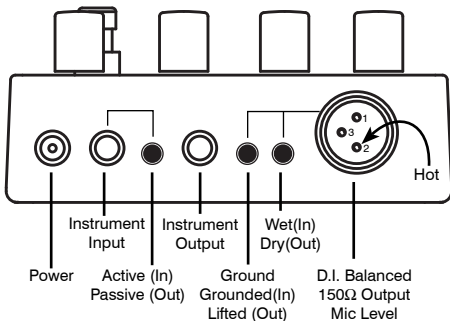

## a. Direct By-Pass

When the unit is switched “off” (no effect) your instrument is routed directly to the output jack and does not pass through any electronics.

## b. Input

When plugging in, make sure you set the input active/passive switch to match your instrument’s pickup. This assures the optimum level and impedance match. ***The power is automatically switched***

***on or off by inserting or removing the plug from the input jack. Simply removing the plug from your instrument does not turn off the Aphex unit.***

### **c. Instrument Output**

Connect this output to your amp's input jack using a good quality guitar cord. Use the same jack and active/passive settings on your amplifier as you would use if plugging the instrument directly into the amp. That way, you'll get normal volume and tone when you switch the effect off, and your instrument passes directly through the box to your amp's input.

### **d. D.I. Output**

Yes, your Xciter™ comes with a super quality balanced D.I. output! Pin 2 of the XLR is hot while pin 3 carries a balancing impedance to set up a true balanced line. Pin 1 is grounded through the ground-lift switch. The D.I. output can be connected to the microphone input of any preamp or sound mixer and runs a level of typically -50 to -60 dBu depending on your instrument's volume setting. You can switch the D.I. output to either wet (with effect) or dry (without effect) buffered balanced output. The D.I. output



should normally be grounded. Don't lift the ground unless it actually eliminates hum or buzz.

### **e. External Power**

When external power is used, the internal battery becomes disconnected and will not experience a power drain. A wide range of both a.c. and d.c. supply voltages is acceptable for power (see specifications) and it does not matter whether the center pin is positive or negative. Almost any existing foot pedal or stomp box power unit will work as long as the plug fits the jack. The power jack fits a standard 6MM x 2MM power plug as used by most popular stomp boxes. The Aphex Model 9 power adapter is specifically designed for Model 1401, 1402, and 1403 Xcitors.

### **f. 9V Battery**

You can use any type of 9V battery that fits the snap connector. You can use rechargables, but the Aphex unit does not supply a charging circuit. You must remove the discharged battery to recharge it with an external charger. We recommend using long life alkalines. The internal battery is replaced by remov-

ing 4 screws holding the bottom cover. You can expect from 100 to 150 hours of continuous use from a fresh alkaline battery. Useful life is ended when the battery voltage drops below 5.5 volts.

***To extend battery life, always unplug the input when the unit is not in use.***

## **Battery Location**

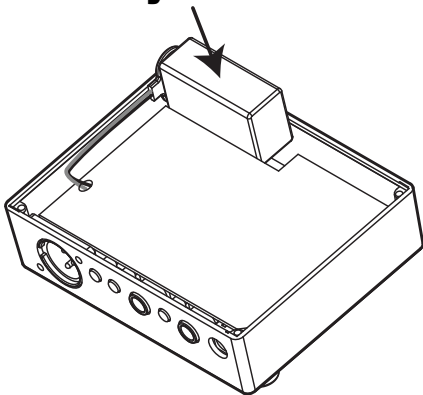

## 2. Controls



### a. **Big Bottom**<sup>®</sup> - What It Does

For bass instruments, it dynamically enhances the low end by deepening and expanding the bass tones according to an adaptive process. It's not just boost. The effect protects speakers while it extends their bass producing capability. For acoustic instruments it "brings out the box". In other words, it adds a



warmer tone that makes the instrument sound bigger and fuller. For guitars, it gives you another dimension of expression at the lower end of the scale. It's not a synthesizer of any kind. It takes what is there and enhances it intelligently.

### **Lo Tune**

Sets the upper frequency limit for bass enhancement. Enhancement occurs for all frequencies below this point. The operating range of this control is optimized for your Xciter model.

### **Lo Blend**

Mixes in the amount of Big Bottom effect you want from zero to the maximum available.

### **b. Aural Exciter® - What It Does**

This is the real and original Aural Exciter especially optimized for musical instruments. It can variously be described as adding “air”, “bite”, “definition” or clarity to the sound by smartly creating and manipulating the harmonics of sound waves. As you will experience, no other “Exciter” has the musicality of the true Aphex Aural Exciter.



## Hi Tune

Sets the lower frequency limit for treble enhancement. Enhancement occurs for all frequencies above this point. The operating range of this control is optimized for your Xciter model.

## Hi Blend

Mixes in the amount of Aural Exciter effect you want from zero to the maximum available.

## c. Foot Switch

Turns the effect on or off. When the effect is off, your instrument is patched directly through to the output jack. In other words, it's a straight bypass. No electronics are in the line at that point.

## d. LED

Glows when the effect is on. Dark when the effect is off. ***If the LED does not operate, then the battery is dead, or no plug has been inserted into the input jack to turn on the unit's power.***

## 3. Tune-Up

### a. The Rules

There's just one rule: Setting up your Xciter is very easy and intuitive. Much more so than many other effects units.

Use the Big Bottom and the Aural Exciter as if they were separate enhancers. After that, it is all up to experimentation. Bear in mind that your amp and speaker play a part in the overall tone of your instrument, just as your pickups do. What settings are great for one rig or instrument might not be perfect for another.

### b. Setting Up Big Bottom

Turn up the Lo Blend to at least 12:00 so you can hear the effect. Rotate the Lo Tune control to hear how the effect changes. Look for the sweet spot as it seems to you. Everyone will find a different sweet spot depending on their instrument's tonality and their personal preferences. Readjust the Lo Blend until you feel the effect is just right.

You will notice that, within a fairly broad range, the Lo Blend will cause a special kind of balance where it does not bloat the sound, but it does extend and deepen the tone. For bass instruments, this is where the Big Bottom is doing what no other processor can do: giving you more effective bass power without overloading your amplifier. This is also where you are getting the most playable enhancement for acoustic guitar, or other non-stringed amplified instruments. It won't seem like compression or straight EQ. It will feel natural, and you will be in love with it. On either side of that blend range, you still get useful effects, and may often choose to go there as well.

## Big Bottom

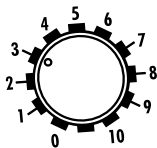

**Lo Tune**

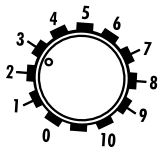

**Lo Blend**

## Aural **EXCITER**

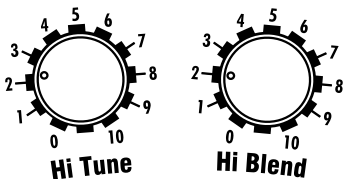

### **c. Setting Up Aural Excitement**

Turn the Hi Blend up to at least 12:00 so you can hear the effect. Rotate the Hi Tune looking for a sweet spot. This can be anywhere in the control range depending on what you are looking for. If you just want air, tune it higher and use more blend. If you want the tone to be more penetrating, tune it lower. For bass, a lower tune gives you more buzz and slap. For non-stringed instruments like accordions, horns, or synthesizers, mid settings may bring you the vibrance and definition you are looking for. It's important to experiment and find all the various ways you like to set up the Aural Exciter.

## 4. Theory

It you are reading this, congratulations! Not everyone will find their way here to learn exactly how the Big Bottom and Aural Exciter work. We'll keep this description light and not too technical, however. We want as many musicians as possible to get a basic grasp of the technology. If you want more than we offer here, then you can find detailed white papers at [www.aphex.com](http://www.aphex.com).

### **First - The History**

In 1975, Aphex introduced the first Aural Exciter® and won U.S and foreign patents. Very soon, the magic of Aural Excitement was discovered by recording and touring artists all over the world. It didn't take long for competitors to elbow in, but they never created anything as good as a real Aural Exciter. With all the Aural Exciter improvements made by Aphex over the years, that is still true today.

In 1990, Aphex introduced the legendary Big Bottom® to balance out the benefits of the Aural Exciter. Big Bottom is now as sought after as Aural

Excitement and is renown in its own right. Still, Aphex offers both effects together because, as powerful as they are alone, they are doubly powerful when used together.

### **The Aural Exciter - What Is It?**

Once sound is recorded, mixed, and reproduced it has lost something vital. We all sense that, especially when we are working at playing or producing music. Part of what gets lost is harmonics.

We can sense the slightest loss of realism when we listen, even as our ears lose acuity with age. That's because our brain is constantly interpreting and adapting to our hearing. It's a process called "psychoacoustics". When small sonic details are lost, we can still interpret the sound, but it gets harder as more sonic "cues" (tiny embedded harmonic details) are lost through electronics or other media.

The Aural Exciter convincingly recreates minute harmonic details of sound. It's true, other manufacturers are now offering harmonics effects that are in some ways similar to our original Aural Exciter of the 1970's, but only Aphex has the patented "Transient

---



Discriminate Harmonics Generator”, a giant leap forward in psychoacoustics processing. The difference is that the Apex Aural Exciter is natural and automatically adaptive to every sound while the others are harsh, and, frankly, just sound like distortion most of the time

So, what can it do? In extreme cases, the Aural Exciter can bring back lost intelligibility to voice recordings and sound reinforcement systems. In milder cases, it can make a the sound seem more vibrant and present - more “real”. For musical instruments, the Aural Exciter can create musical effects not obtainable any other way. It can make your instrument project better off the stage or give you a richer, more realistic feeling. It can help you play better because you are psychoacoustically more in tune - and the audience experiences the same effect. They start getting your message!

OK - now here is the real tech stuff. The audio input splits to a main path and a side chain. The side chain comprises an adjustable highpass filter (the Hi Tune) followed by a transient discriminate harmonics gen-



erator. The highpassed frequencies coming out of the side chain contain added harmonic details in varying amounts depending upon the dynamics of the sound. The phase and timing of the side chain audio signals are also altered in a certain way. The main path mixes the unaltered sound with an amount of the side chain sound. The mixed amount is set by the Hi Blend control.

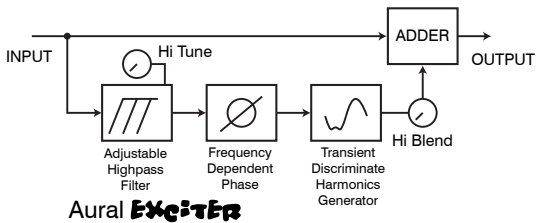

## The Big Bottom - What Is It?

Low frequencies are the most difficult to reproduce well. That is because of many problems involving acoustic mass, standing waves, and acoustic interference. It takes huge amounts of power to project a strong bass note. Those of you who are bass players know that. Simply giving bass frequencies



more power can heighten the volume level, but at some point it is impractical to go any further. Big Bottom was developed to get an extended and stronger bottom end with existing amps and speakers. Whereas the Aural Exciter clarifies and projects the sonic details mainly carried in the upper frequencies, Big Bottom improves the low end reproduction.

In certain ways, Big Bottom behaves like a bass compressor, because it extends and sustains the notes. But, unlike a compressor, it does nothing to stop the leading edge of transients. It does not reduce or diffuse the snap, pluck, or punch. And, because it uses a dynamic, constantly changing kind of boost, it progressively augments the deeper tones as they decay, making the notes more solid and allowing your amp and speakers to develop their maximum output more safely.

Now, it may come to mind that this is obviously a good thing for bass instruments, but what about others? Why do I need the Big Bottom for acoustic guitar, for example? The answer is this. We have discovered, by making the Big Bottom's range of

frequencies adjustable, that the specific process is musically adaptive to upper bass areas as well. It's all about tone. The "box" of the guitar can be warmly accented without making it thuddy. The richness of chords can be improved. Amplified horns receive an exhilarating reach to the lower notes. Of course, not all instruments can benefit. We doubt whether Big Bottom does much for a Cornet, for example. But, you never know until you try! We have been pleasantly surprised many times.

Now the tech stuff again. Big Bottom starts by splitting the unaltered input signal to a main path and a side chain. The side chain comprises an adjustable lowpass filter (Lo Tune), a frequency dependent phase shifter, and a peak limiter. The output from the side chain is added to the unaltered signal in an adjustable amount set by the Lo Blend. The characteristics of the phase shifter and peak limiter have been highly refined though extensive research.

The result of this combination of processing is a variable amount of low frequency equalization that slides through a range of shapes and frequencies continuously as the note is played and decays. The

---

manner and direction of this dynamic EQ enhances the note's apparent depth while limiting the peak energy level to what is about equal to the unaltered sound. That means your amp and speakers are not overloaded even when the sound is greatly magnified.

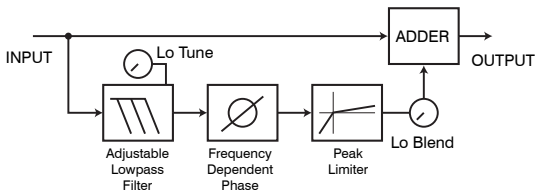

## Big Bottom

## 5. Specifications

Model	1401 Acoustic	1402 Bass	1403 Guitar
Input Z	Active: 50K $\Omega$ Passive: 10M $\Omega$	Active: 50K $\Omega$ Passive: 1M $\Omega$	Active: 50K $\Omega$ Passive: 1M $\Omega$
Output Z	Instrument: 1K $\Omega$ D.I.: 150 $\Omega$	Instrument: 1K $\Omega$ D.I.: 150 $\Omega$	Instrument: 1K $\Omega$ D.I.: 150 $\Omega$
Lo Tune	40-210Hz	30-210Hz	40-210Hz
Hi Tune	300-3kHz	500-5kHz	500-5kHz
Maximum Input Level	Passive: 0.6V RMS Active: 2.4V RMS	Passive: 0.6V RMS Active: 2.4V RMS	Passive: 0.6V RMS Active: 2.4V RMS
Freq. Resp.	10Hz-30kHz +/- 1dB	10Hz-30kHz +/- 1dB	10Hz-30kHz +/- 1dB
SNR (Typical)	70dB	70dB	70dB
Power Drain	5mA	5mA	5mA
Battery Type	9V	9V	9V
External Power	5-12VAC 7-17VDC	5-12VAC 7-17VDC	5-12VAC 7-17VDC

Apex reserves the right to continually improve our products. All specifications are subject to change without notice.



## 6. Limited Warranty

### PERIOD

One year from date of purchase

### SCOPE

All defects in workmanship and materials. The following are not covered:

- a. Voltage conversions
- b. Units on which the serial number has been defaced, modified, or removed
- c. Damage or deterioration:
  1. Resulting from installation and/or removal of the unit.
  2. Resulting from accident, misuse, abuse, neglect, unauthorized product modification or failure to follow instructions contained in the User's Manual.
  3. Resulting from repair or attempted repair by anyone not authorized by ApHex Systems.
  4. Occurring from shipping (claims must be presented to shipper).

### WHO IS PROTECTED

This warranty will be enforceable by the original purchaser and by any subsequent owner(s) during the warranty period, so long as a copy of the original Bill of Sale is submitted whenever warranty service is required.

### WHAT WE WILL PAY FOR

We will pay for all labor and material expenses for covered items. We will pay return shipping charges if the repairs are covered by the warranty.

### LIMITATION OF WARRANTY

No warranty is made, either expressed or implied, as to the merchantability and fitness for any particular purpose. Any and all warranties are limited to the duration of the warranty stated above.

### EXCLUSION OF CERTAIN DAMAGES

ApHex Systems' liability for any defective unit is limited to the repair or replacement of said unit, at our option, and shall not include damages of any other kind, whether incidental, consequential, or otherwise.

Some States do not allow limitations on how long an implied warranty lasts and/or do not allow the exclusion or limitation of incidental or consequential damages, so the above limitations and exclusions may not apply to you.

This warranty gives you specific legal rights, and you may also have other rights which vary from State to State.

## 7. Service Information

1. If it becomes necessary to return this unit for repair, you must first contact Aphex Systems, Ltd. for a Return Authorization (RMA number).
2. Pack the equipment in a strong carton containing at least 2 inches of padding on all sides. Be sure the unit cannot shift around inside the carton. Include a letter explaining the symptoms and/or defect(s). Be sure to reference the RMA number in your letter and mark the RMA number on the outside of the carton.
3. If you believe the problem should be covered under the terms of the warranty, you must also include proof of purchase.
4. Insure your shipment and send it to:

Aphex Systems, Ltd.  
11068 Randall Street  
Sun Valley, CA. 91352  
PH: (818) 767-2929 FAX: (818) 767 -2641

---

**Aphex** is a leading manufacturer of products for recording, broadcast, and sound reinforcement. Be sure to ask your dealer about professional Aphex products or visit **[www.aphex.com](http://www.aphex.com)** for more information.

“**Bass Xciter**”, “**Guitar Xciter**”, and “**Acoustic Xciter**” are trademarks of Aphex Systems Ltd. All rights reserved.

Aphex Systems Ltd.  
11068 Randall St.  
Sun Valley, CA 91352  
Tel 818-767-2929  
[techsup@aphex.com](mailto:techsup@aphex.com) | [sales@aphex.com](mailto:sales@aphex.com)

---